



210W Single Output Switching Power Supply LL-DR-38V1A85-210WYT series

Features:

- Universal AC input / Full range(100-277V)
- Built-in active PFC function
- Always-on Auxiliary Power: 12Vdc, 30mA (Transient Peak Current up to 50mA)
- Protections:Short circuit / Over voltage
- LVLE power unit
- Three in one dimming function (0-10Vdc or PWM or resistance)
- Suitable Wet locations
- 100% full load burn-in test
- High Efficiency :88%-92%(Typ.)
- 5 years warranty

SPECIFICATION

MODEL		LL-DR-38V1A85-210WYT
OUTPUT	DC VOLTAGE(Max)	44V
	CONSTANT CURRENT REGION	23-38V
	RATED CURRENT	1.85A
	RIPPLE&NOISE(max.)	100mVp-p
	CURREN TOLERANCE	±10%
	LINE REGULATION	±2%
	LOAD REGULATION	±5%
	SETUP,RISETIME	<2000ms/ 115VAC at full load , <1000ms / 277V AC at full load
	HOLD UP TIME(TYP)	16ms at full load 100VAC/277VAC
INPUT	VOLTAGE RANGE	100~277VAC
	FREQUENCY RANGE	47~63Hz
	RATED POWER	75W
	POWER FACTOR(Typ)	PF>0.92/100VAC~277VAC at full load
	THD	<20%
	EFFICIENCY(Typ.)	88%
	ACCURRENT AT 75W (TYP)	0.75A / 100VAC, 0.27A /277VAC
	INRUSH CURRENT(TYP)	COLD START 75A at 277VAC
LEAKAGE CURRENT	<0.75mA/277VAC	
PROTE CTION	OVER CIRCUIT	95-110 % Protection type : Constant current limiting, recovers automatically after fault condition is removed
	Integral short circuit	Hiccup mode, recovers automatically after fault condition is removed
	Open Voltage protection	48-58V Protection type : Shut down and latch off o/p voltage, re-power on to recover
	Overload protection	105-120 % Hiccup mode, recovers automatically after fault condition is removed
	WORKING TEMP.	-40 ~ +60°C
ENVIRO NMENT	WORKING HUMIDITY	20~95%RH non-condensing
	STORAGE TEMP.,HUMIDITY	-40 ~ +80°C , 10 ~ 95%RH
	TEMP.COEFFICIENT	±0.03%/°C(0~50°C)
	VIBRATION	10~500Hz, 2G 12 min./1cycle, period for 72 min.each along X,Y,Z axes
	SAFETY STANDARDS	design refer to UL8750, CSA C22.2 No. 250.0-08, EN61347-1, EN61347-2-13, UL60950-1, TUV EN60950-1



210W Single Output Switching Power Supply LL-DR-38V1A85-210WYT series

SAFETY & EMC	WITHSTAND VOLTAGE	I/P-O/P:3.75KVAC I/P-FG: 2KVAC O/P-FG:0.5KVAC
	ISOLATION RESISTANCE	I/P-O/P , I/P-FG , O/P-FG : 100M Ohms /500VDC /25°C//70%RH
	EMC EMISSION	Compliance to EN55015, EN61000-3-2 Class C ;EN61000-3-3
	EMC IMMUNITY	Compliance to EN61000-4-2,3,4,5,6,8,11, EN61547, EN55024, light industry level (surge 4KV),criteria A
OTHERS	MTBF	300Khrs min. MIL-HDBK-217F(25°C)
	DIMENSION	241*49*31.4mm(L*W*H)
	PACKING	
NOTE	Suffix "XAXX" after letter V is 4 digit number which represents the output current in ampere for each output channel, for example, "5A00" means 5.0 A, "0A67" means 0.67 A. Suffix "Y" after letter 240W is "D" or "N",suffix "D" which represents the dimmer type,suffix "N" which represents no dimmer type.	

Mechanical Specification

Remark: Support 0-10Vdc or PWM or resistance dimming function.

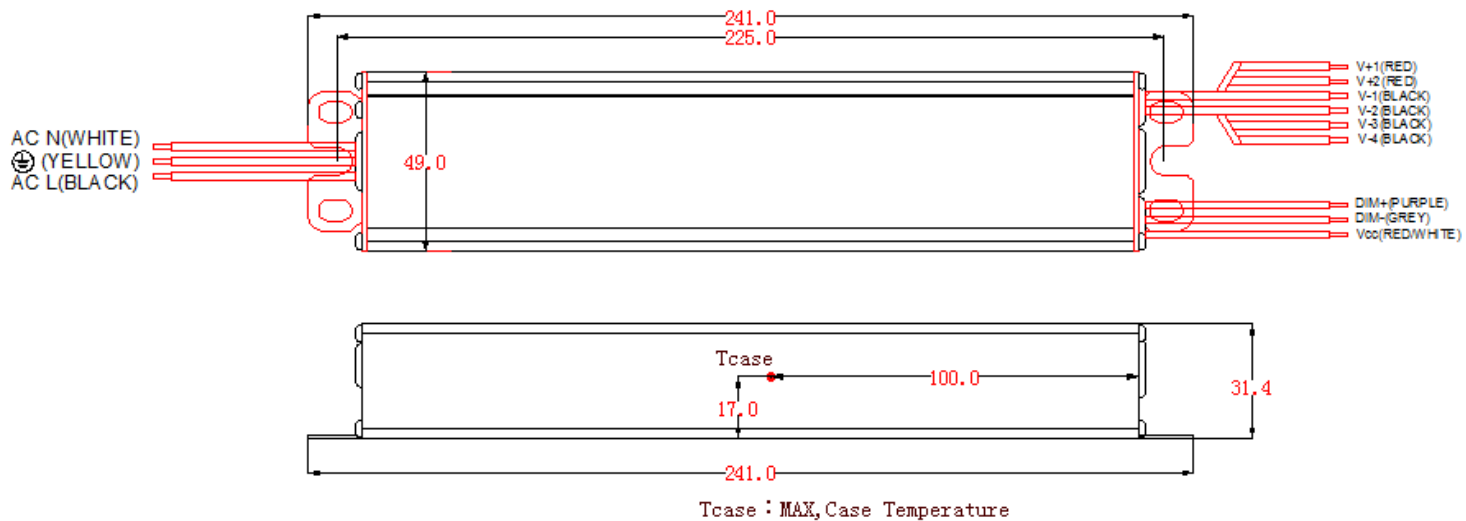

Remark: without dimming switch.

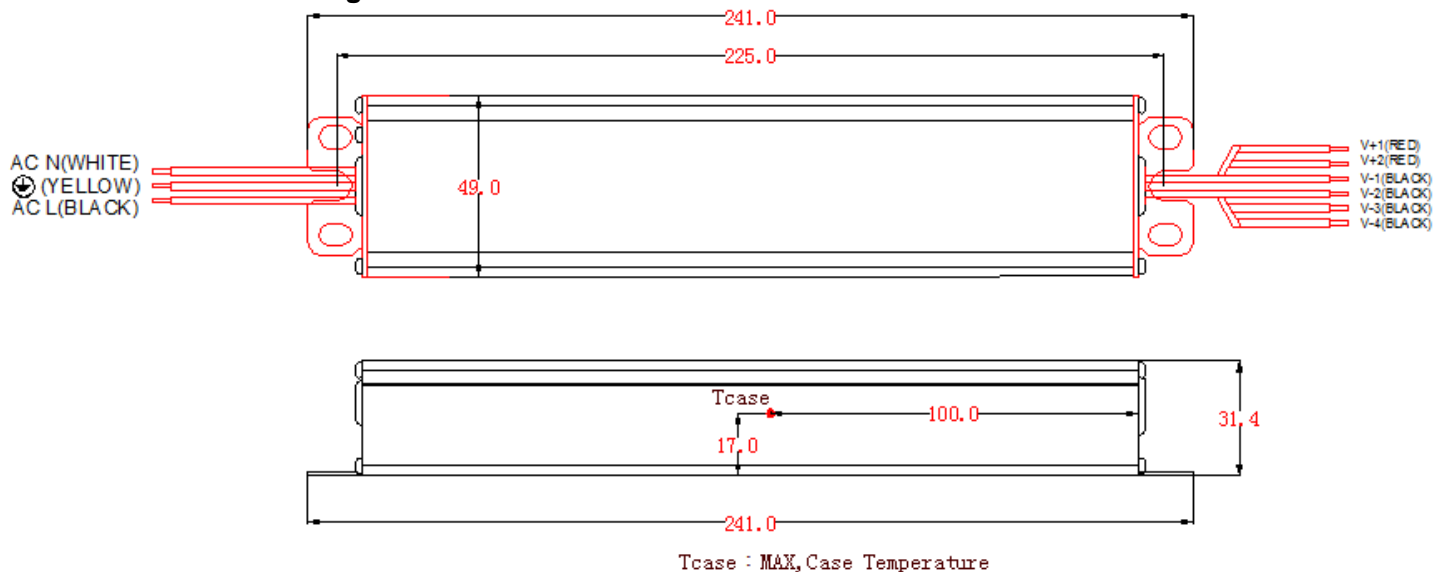

Remark:X=D,P;Support 0-10Vdc or PWM or resistance dimming function,with or without dimming switch(4 bit)

210W Single Output Switching Power Supply LL-DR-38V1A85-210WYT series

Block Diagram

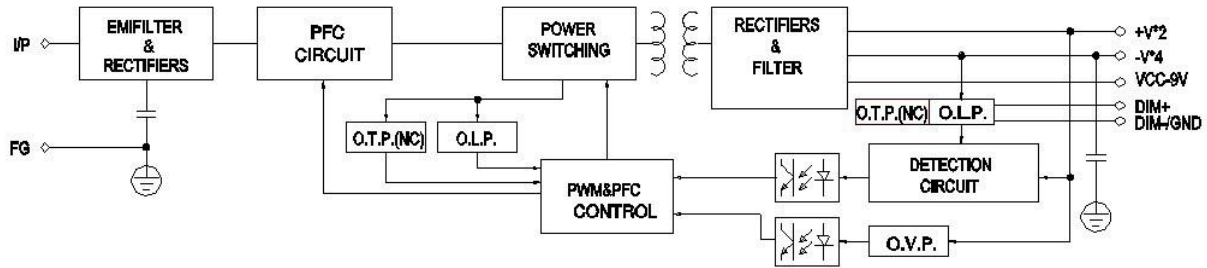

The life time curve:										
TC (°C)	60°C	65°C	70°C	75°C	80°C	85°C	90°C	95°C	100°C	105°C
TA (°C)	25°C	30°C	35°C	40°C	45°C	50°C	55°C	60°C	65°C	70°C
The power of life (Hour)	323531	239850	190225	133791	92923	75409	59646	57311	53029	50110

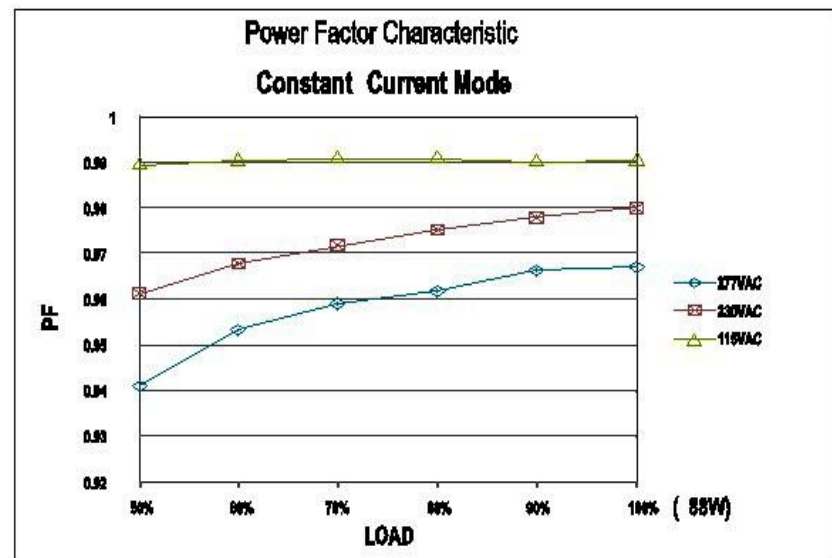
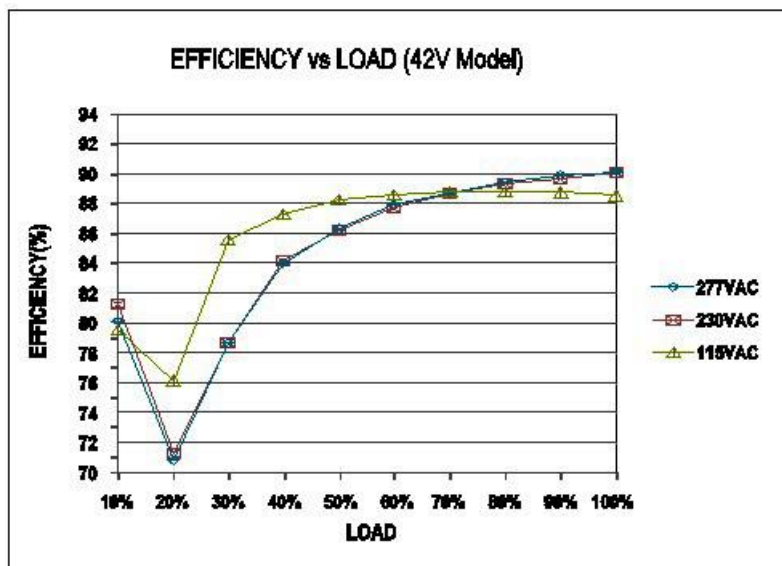

DRIVING METHODS OF LED MODULE
 This LED power supply is suggested to work in constant current mode area (CC) to drive the LEDs



210W Single Output Switching Power Supply LL-DR-38V1A85-210WYT series

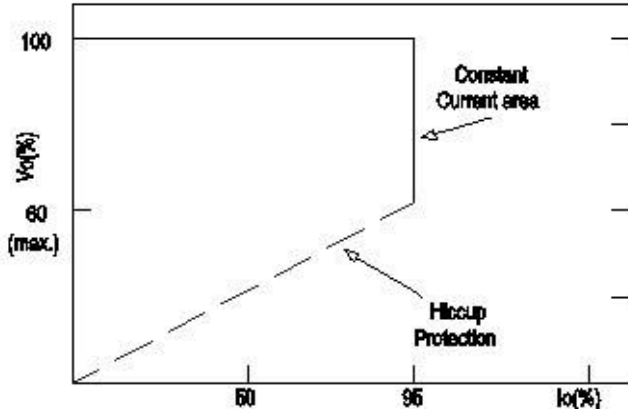

Typical LED power supply I-V curve

DIMMING OPERATION

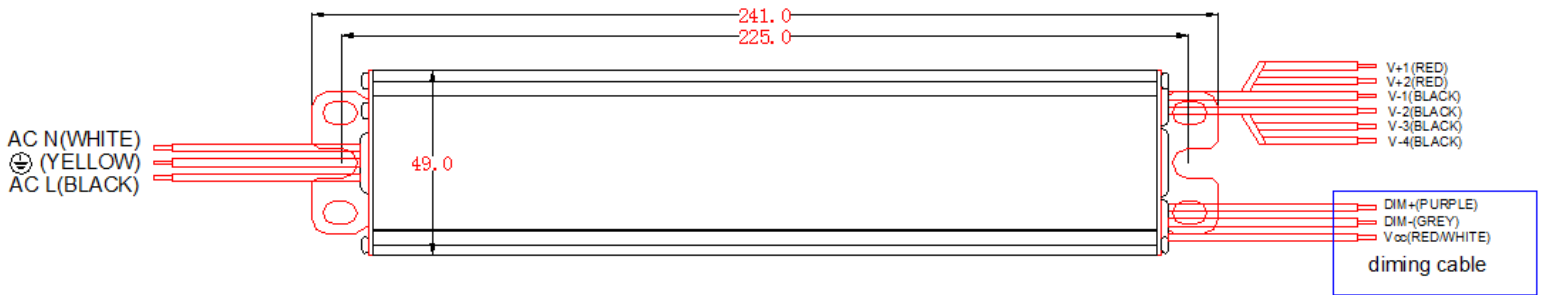

Built-in 3 in 1 dimming function, output constant current level can be adjusted through dimming cable by connecting a resistance or 0~10Vdc or 10V PWM signal between DIM+ and GND. Please DO NOT connect "DIM-" to "V-1".

Reference resistance value for output current adjustment (Typical)

Resistance value	Single driver	0 Ω	10K Ω	20K Ω	30K Ω	40K Ω	50K Ω	60K Ω	70K Ω	80K Ω	90K Ω	100K Ω	OPEN
	Multiple drivers (N=driver quantity for synchronized dimming operation)	0Ω /N	10KΩ /N	20KΩ /N	30KΩ /N	40KΩ /N	50KΩ /N	60KΩ /N	70KΩ /N	80KΩ /N	90KΩ /N	100KΩ /N	-----
Percentage of rated current		0%	10%	20%	30%	40%	50%	60%	70%	80%	90%	100%	95%-110%

0~10V dimming function for output current adjustment (Typical)

Dimming value	0V	1V	2V	3V	4V	5V	6V	7V	8V	9V	10V	OPEN
Percentage of rated current	0%	10%	20%	30%	40%	50%	60%	70%	80%	90%	100%	95%-110%

10V PWM signal for output current adjustment (Typical): Frequency range: 100HZ~3KHz

Duty value	0%	10%	20%	30%	40%	50%	60%	70%	80%	90%	100%	OPEN
Percentage of rated current	0%	10%	20%	30%	40%	50%	50%	70%	80%	90%	100%	95%-110%

Using the built-in dimming function can't turn the lighting fixture to tally dark. Please refer to the connection method below to achieve 0% brightness of the lighting fixture connecting to the LED power supply unit.

Dimming connection diagram for turning the lighting fixture ON/OFF:



210W Single Output Switching Power Supply LL-DR-38V1A85-210WYT series

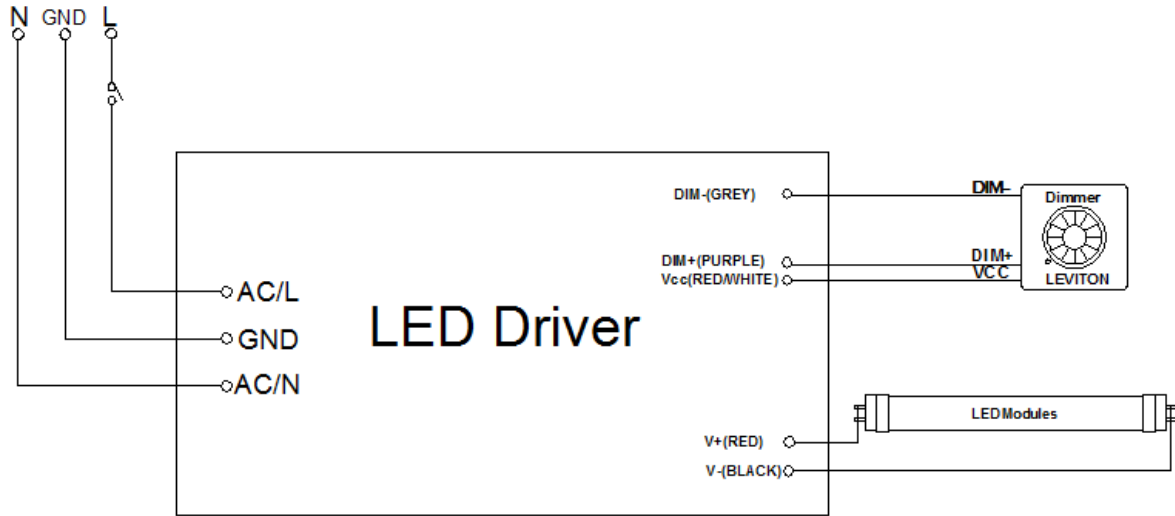

Using a switch and relay can turn ON/OFF the lighting fixture.

1. Out put constant current level can be adjusted through dimming cable by connecting a resistance or 0~10Vdc or 10V PWM signal between DIM+ and DIM-.
2. The LED lighting fixture can be turned ON/OFF by the switch or dimming.